

MSM 12

Mobile Rope Load Measurement Manual

for sensors LSM 1, LSM 2, LSM XL, LSM 2000
LSM Belt

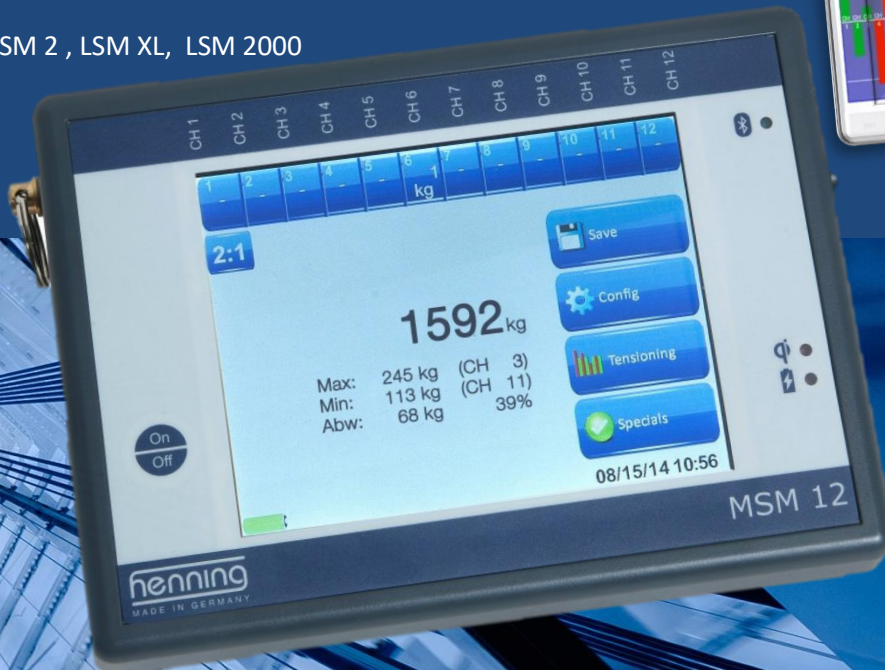
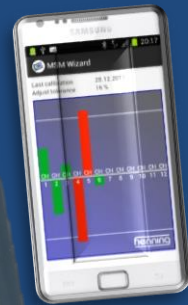

Copyright

© Copyright 2018 by Henning GmbH & Co KG, Loher Str. 4, 58332 Schwelm

Warranty

This manual has been drawn up by **Henning GmbH & Co. KG** to the best of their knowledge. All technical statements have been carefully established and checked. They correspond to the state of the art. Subject to changes and errors.

Our application engineering advice – orally as well as in writing – shall support your ownwork. Please regard it as an indication without obligation, also with regard to possible third party industrial property rights, and does not release you from your own obligation to carry out appropriate testing of the products regarding their suitability for the intended application.

Product descriptions do not contain statements about liability for possible damages. However, should the case occur, liability will be limited to the value of the goods supplied and utilized.

We are welcoming suggestions and comments!

Address

Henning GmbH & Co. KG

**Loher Str. 4
58332 Schwelm
Deutschland**

FON: 02336 / 9 29 8 – 0
FAX: 02336 / 9 29 8 – 100

eMail: info@henning-gmbh.de
URL : <http://www.henning-gmbh.de>

Service-Hotline: 02336 / 9 29 8 - 232

Any kind of duplication, even in extracts, is not permitted without previous written consent of Henning GmbH & Co. KG.

Subject to technical modifications!

Table of Contents

1	Safety and Shipping Instruction	4
2.	Scope of Delivery	4
2.A.	Optional Equipment	4
2.B.	Optional Software	4
3.	Control Elements	5
4.	Technical Data	5
5.	List of Available Sensors	6-7
6.	Operating the Evaluation unit MSM12	8
6.A.	Charging the Batteries	8
6.A.1	USB-Adapter	8
6.A.2	Qi-Ladung	8
6.B.	Starting the Device	9
6.C.	Main Display	10-11
6.C.1	Sensor Information	12
6.D.	Choosing Suspension Type	13
6.E.	Saving Data	13
6.E.1	Save actual sensor results-snapshots	13
6.E.2	Continuous Measurements (optional)	14
6.E.3	Allocation of project-ID	15
6.F.	Configuration	16
6.F.1	Unit Info	17
6.G.	Rope Adjustment Wizard	17-18
6.H.	Special Functions	19
6.H.1	Continuous Measurements (optional)	19
6.H.2	Counterweight Compensation	19-20
6.H.3	SyncMaster	21
6.I.	Bluetooth Connection with PC	21-23
6.J.	Bluetooth Connection with Android Smartphone	24
7.	Operating the Sensors	25
7.A.	General Notes	25
7.A.1	Positioning of Sensors on the Rope	26-28
7.A.2	Positioning of Sensors depending on Suspension Type	29
7.A.3	Rope Adjustment	29
7.A.4	Friction / Determination of Weight	29
7.B.	Installation of Sensors LSM1 und LSM2	30-31
7.C.	Installation of Sensors LSM-XL	32-33
7.D.	Installation of Sensors LSM-BELT	34

1 Safety and Shipping Instruction

The Evaluation units MSM12 V3 are equipped with lithium - ion batteries.

Safety Instructions

- Lithium-ion batteries react violently when coming into contact with water (fully charged ones in particular)
- Do not store Li-Ion batteries near combustible material
- Do not overcharge Li-Ion batteries
- Do not short-circuit Li-Ion batteries
- Li-Ion batteries are sensitive to mechanical damage. After internal short-circuiting and contact with air they may be highly combustible (even 30 minutes after the actual short circuiting).

Shipping Instructions

The batteries contained in the evaluation units MSM 12 comply with UN 3481, li-ion batteries contained in equipment (UN-regulations governing the shipment of lithium batteries of 1st January 2009). Please observe special restrictions in connection with li-ion batteries, especially regarding airfreight and / or request appropriate information from your logistics partner before shipping.

2 Scope of Delivery

1x mobile evaluation unit MSM12
Version Basic, Extended or Premium
1x USB-connection cable
1x charger 230V

2.A Optional Equipment

Qi-Charger	Order Code 455097
USB-Charger	Order Code 455096
Protection Bag	Order code 455099

2.B Optional Software

Curve Storage

Measures and stores the rope tensions / individual weights during the ride e.g. to allow sets of ropes to be optimized later. **Order Code 455155**

Counterweight Compensation Measurement

Assistant allowing counterweight compensation to be simplified without the use of weights or additional tools, storage and preparation of reports for future documentation. **Order Code 455160**

3 Control Elements

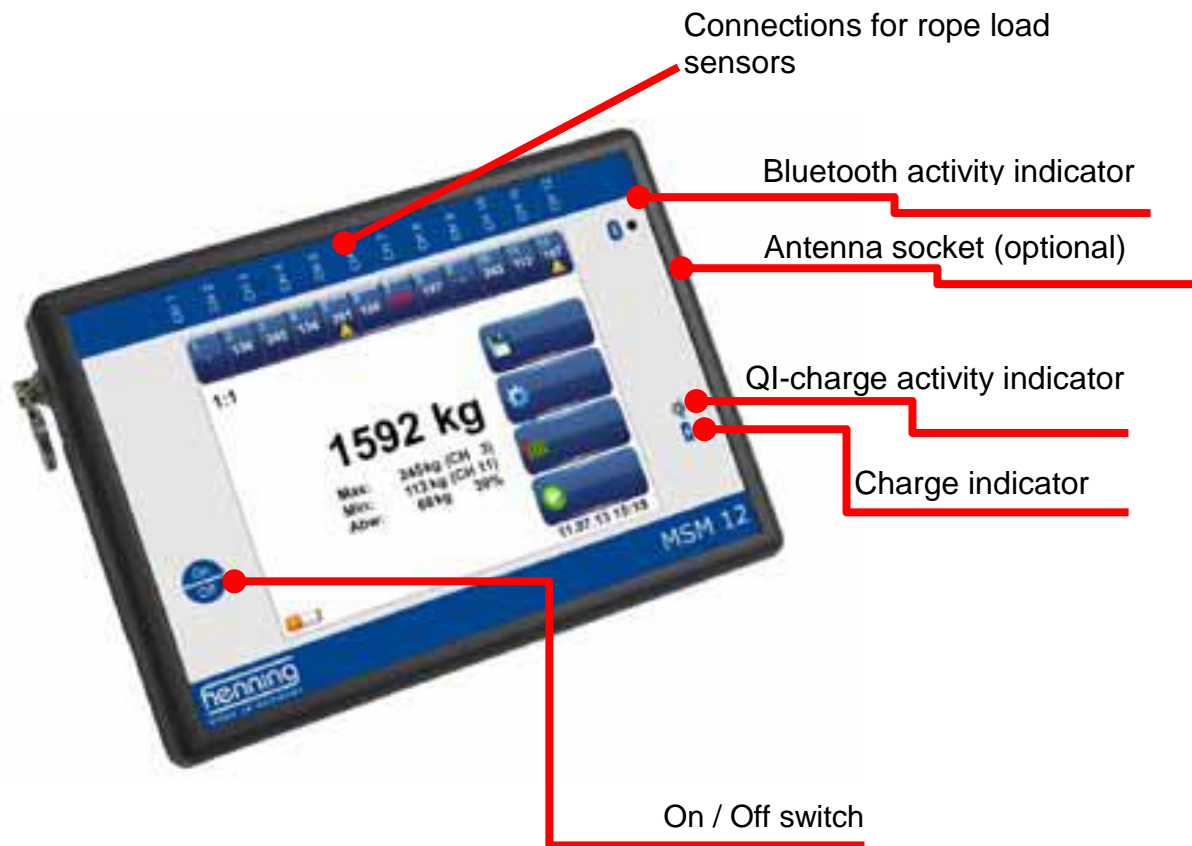

4 Technical Data

Power is supplied by internal lithium-ion batteries with a capacity of 4,5 AH (Basic), 6,75 AH (Premium) oder 9 AH (Extended).

Sensor Connections:	12
Bandwidth:	30 Hz
Sample frequency:	100 Hz
Connections:	USB, BlueTooth (optional)
Protection Class:	IP00 SKIII (SELV)
L x W x H (mm):	190 x 138 x 46
Weight:	650 g

5 List of available Sensors



Mobile Rope Load Sensor LSM 1 (6 - 16 mm, 1/4 inch – 5/8 inch)

For Rope Diameters	6 mm - 16 mm 1/4 inch – 5/8 inch
Measuring Range	0 - 500 kg (± 2,5% FSR), 0-1100 lbs (± 2,5% FSR)
Maximum Load	1000 kg, 2200 lbs
Breaking Load	2000 kg, 4400 lbs
L x W x H (mm)	250 x 75 x 19
Length of Connecting Cable	0,8 m, 31,5 inch
Temperature Range	0 °C - 70 °C



Mobile Rope Load Sensor LSM 2 (4 - 10 mm) (3/16 inch – 3/8 inch)

For Rope Diameters	4 mm - 10 mm (3/16 inch – 3/8 inch)
Measuring Range	0 - 300 kg (± 2,5% FSR), 0-660 lbs (± 2,5% FSR)
Maximum Load	600 kg, 1320 lbs
Breaking Load	1200 kg, 2640 lbs
L x W x H (mm)	178 x 58 x 16
Length of Connecting Cable	0,8 m, 31,5 inch
Temperature Range	0 °C - 70 °C

Mobile Rope Load Sensor LSM-XL (9,5 - 24 mm) ($\frac{3}{8}$ inch – $\frac{15}{16}$ inch)



For Rope Diameters 9,5 mm – 24 mm
($\frac{3}{8}$ inch – $\frac{15}{16}$ inch)

Measuring Range 200 - 2000 kg ($\pm 2,5\%$ FSR),
400-4500 lbs ($\pm 2,5\%$ FSR)

Maximum Load 4000 kg, 9000 lbs

Breaking Load 6000 kg, 13500 lbs

L x W x H (mm) 570 x 210 x 50

Length of Connecting Cable 1,5 m, 59 inch

Temperature Range 0 °C - 70 °C

Mobile Rope load Sensor LSM-Belt



For Belts 30 mm and 60 mm

Measuring Range 0 - 500 kg
($\pm 2,5\%$ FSR),

0-1100 lbs ($\pm 2,5\%$ FSR)

Maximum Load 1000 kg, 2200 lbs

Breaking Load 2000 kg, 4400 lbs

L x W x H (mm) 230 x 120 x 82

Length of

Connecting Cable 0,8 m, 31,5 inch

Temperature Range 0 °C - 70 °C

6 Operating the Evaluation unit MSM12

General Advice

Please protect the evaluation unit MSM12 against dust, moisture and impact. We recommend the optional protection case made from padded cordura, incorporating a large transparent window.

Protection Bag **Order Code 455099**

6.A Charging the Batteries

When switched on, the main screen shows the batterie's current state of charge. Please charge the batterie as soon as the battery status changes to red status. During charging, the charge control changes to continuously red light.

Important notice: Please switch the unit off while charging, as otherwise most of the energy will be used up for the operation of the unit.

6.A.1 USB-Adapter

For charging via USB-connection, please connect the MSM12 with the USB-cable to the charging adapter and connect the adapter to the main power supply. Charging will take, depending on the state of the batteries, between 9 and 18 hours.

6.A.2 Qi-Charging

For charging via Qi-interface, please connect the Qi-charger to the USB charging adapter. Place the evaluation unit MSM12 onto the center of the charger, main screen facing away from the charger. If positioned correctly, the charge control will change into active mode and the Qi-charge indicator will be activated after ca. 2 seconds. Charging will take up to 9 hours.

6.B Starting the Device

In order to switch on the MSM12 mobile rope load meter please press the on/off switch for a minimum of 3 seconds. The display now shows the Weight Watcher logo as well as a progress bar. After a short time the display switches over to the main display. The MSM12 is now ready for operation.

To switch off please press the on/off switch for minimum 3 seconds again. The device switches off and the display lighting is extinguished. If the batteries are run-down, the MSM12 switches off automatically.



6.C Main Display

Below, the main display of the mobile rope load evaluation unit MSM12 is shown. The upper two lines display the status bar indicating the individual weight of each rope under the corresponding measuring channel number.

Below, in the centre, the total weight resulting from the individual weights as well as the maximum individual load, minimum individual load and the maximum deviation and the corresponding measuring channel numbers are indicated. At the right side four menu keys are to be found which will be described in detail later. In the lower left-hand corner the charge status of the batteries is displayed. On the upper left below the status bar the selected suspension ratio is shown.

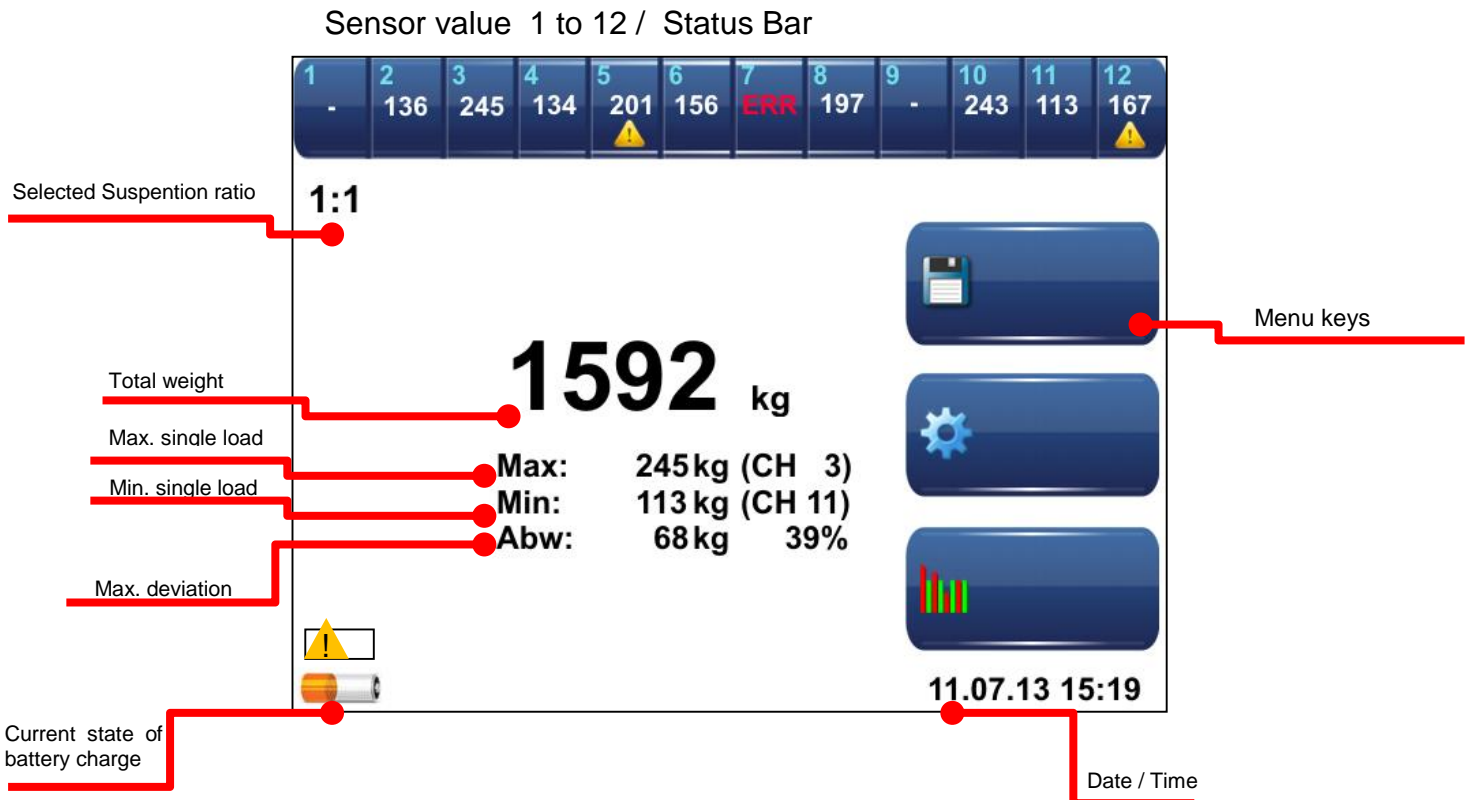

The individual sensor display shows the measured load of each connected rope load sensor.

Please note: The load in the status bar on top will not be calculated on the basis of the selected suspension ratio.

If a connected sensor is defective, *ERR* will be displayed. The yellow warning-triangle  will show up, as soon as the calibration of the corresponding sensor has expired.

A touch on one of the sensor-keys in the status bar will open a separate window showing the data of the corresponding sensor (see also 6.C.1 “sensor-information”).

The suspension ratio of the elevator can be selected manually by the user. The displayed total weight is calculated by this factor. The individual weight displayed per sensor remains unaffected (see also 6.D “Choosing Suspension Type”).

The total weight is the sum of all individual rope loads measured, converted according to the suspension ratio (if applicable). The output can be selected in different weight units such as kilogram, tons, Newton, English pounds, short tons or long tons.

The maximum individual rope load shows the actual load and the measuring channel number of the sensor which is loaded with the highest weight in the rope set. The minimum individual rope load display shows the corresponding information for the rope with the lowest load.

The maximum deviation shows the deviation (absolute as well as percentage) of the rope with the greatest deviation from the average calculated from all ropes. The example in figure shows a total weight of 1,529 kg distributed among nine ropes. This means that under ideal conditions each rope should carry 177 kg. However, the rope at measuring channel 3 carries 245 kg, i. e. 68 kg (absolute) or 39 % more load(rounding errors possible).

The **calibration warning**  will be displayed, if the last calibration of the evaluation unit has been one year ago (or longer).





6.C.1 Sensor Information

Sensor type:
LSM 1

Serial no.:
00623459

Last calibration:
15.04.2012

 **Last Calibration was more than 365 days ago!**





For the WeightWatcher mobile system four sensor types for different rope diameters are available:

- LSM1 diameter 6 mm – 16 mm ($\frac{1}{4}$ inch – $\frac{5}{8}$ inch)
- LSM2 diameter 4 mm – 10 mm ($\frac{3}{16}$ inch – $\frac{3}{8}$ inch)
- LSM-XL diameter 9,5 mm – 24 mm ($\frac{3}{8}$ inch – $\frac{15}{16}$ inch)
- LSM-BELT for belts 30 mm and 60 mm

6.D Choosing Suspension Type

In this menu section one can enter the suspension ratio of the elevator at which you want to carry out measurements. The ratio is displayed on the main display; however, it is not permanently stored in the evaluation unit. After a restart the evaluation unit will automatically be displaying a suspension of 1 : 1.

By means of the suspension ratio the displayed total weight is calculated. The suspension ratio has no influence on the individual rope loads.

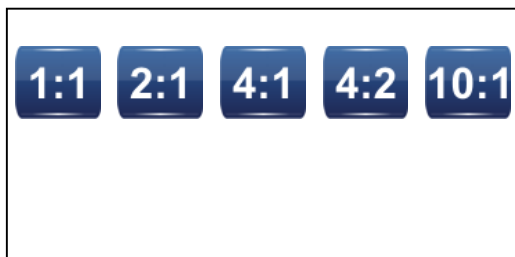

6.E Saving Data

By touching the key „save“, a selection menu opens, in which one can choose between the options “save current weight distribution” and “measurement of load curve”, if you have purchased the optional software “curve storage”. If not, the unit switches automatically to the allocation of the project-ID (see also 6.E.3).

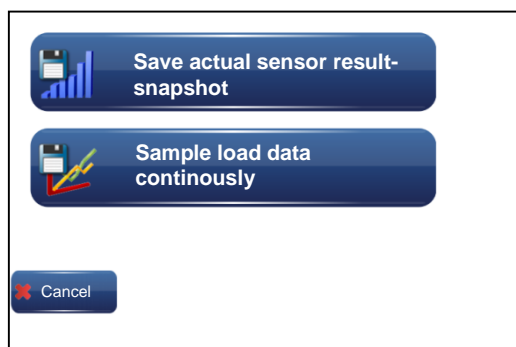

6.E.1 Save actual sensor result-snapshot

As soon as this key is activated, the data of all connected rope load sensors is evaluated; the sensor- and load-data is being saved in the evaluation unit. One can allocate a project-ID at this point (see also 6.E.3). Reports can be issued via the PC-software.

Rope Load Report



Elevator installation

Project: Muster

Lift serial no.:

Street:

ZIP/City:

Country:

Measurement-ID: TU
Suspension: 1:1
Timestamp: 08.01.2014
16:15:56

Results

Evaluation Components

Channel	Load	Model	Serial no.	Last calibration
1	273 kg	MSM12	05060708090A	13.08.2011
2	264 kg	unknown	000000000000	unknown
3	254 kg	unknown	000000000000	unknown
4	263 kg	unknown	000000000000	unknown
5	270 kg	unknown	000000000000	unknown
6	257 kg	unknown	000000000000	unknown

Calibration expired

Total: 1581 kg

Average deviation: 2,09 % [6 kg]

Max. deviation: 3,61 % [10 kg]

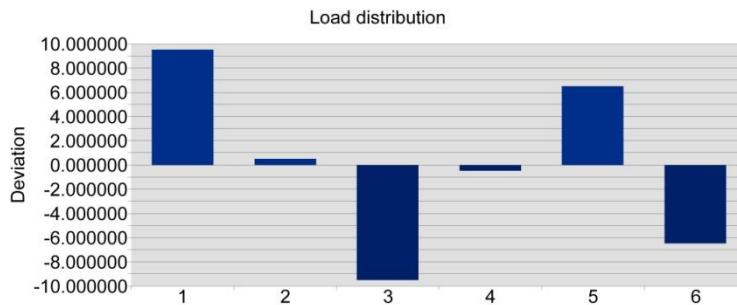

created by Henning WeightWatcher 7/29/2014 www.henning-gmbh.de

6.E.2 Continuous Measurements (optional)

As soon as this key is activated, the data of all connected rope load sensors is evaluated continuously until the measurement is terminated by pressing the key "save".

Important Notice: during the measurement no sensors may be removed oder added!

The data is being saved in the evaluation unit via "allocation of project-ID" and reports can be issued with the PC-software.

Measurement is running...

 Cancel

 Save

6.E.3 Allocation of Project-ID

The project-ID may consist of up to 16 characters which can be chosen randomly. They help to identify the project and will be printed on each report created from this particular data.

 ID



 Cancel

 Save

6.F Configuration

The menu „configuration“ is for selecting language, date, time, display settings as well as tolerances. The latter refers to the tolerance which is valid during rope adjustment. A value of 5% means, that each rope may vary only by 5% from the theoretical ideal value.

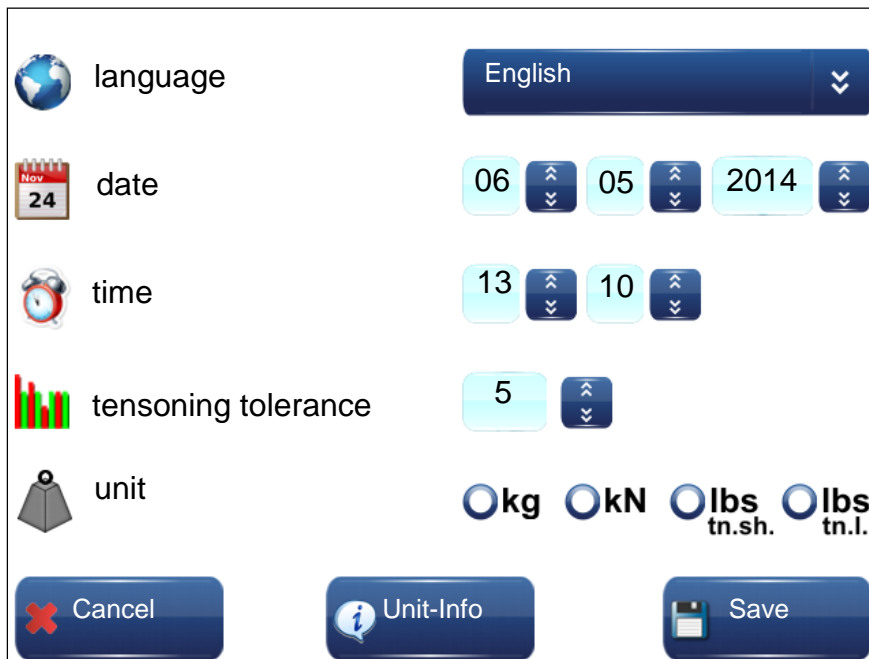

The configuration menu is displayed with the following settings:

- language:** English
- date:** 06 / 05 / 2014
- time:** 13 : 10
- tensioning tolerance:** 5
- unit:** kg kN lbs_{tn.sh.} lbs_{tn.l.}

Buttons at the bottom: Cancel, Unit-Info, Save

The settings are saved as soon as the key “save” is pressed. If a new language has been chosen, the unit will reboot automatically. Please see the following chapter for a definition of the key “Unit Info”.

6.F.1 Unit Info



Serial no.:
00623459

Last calibration:
 **15.04.2012**
Last Calibration was more than 365 days ago!

Hardware options:

Internal memory 8 GB
Battery charge 4,5 Ah

Bluetooth
 Qi-charging
 Sync-master

Software options:

Curve storage during the ride
 Counterweight compensation measurement
 Sync-master

OK

This function shows the user alongside general information like serial number and date the hard- and software installed on this particular unit as well as the date of the last calibration.

The options “Synchronisation Module” and “Sync-Master” will be available from the year 2015.

6.G Rope Adjustment Wizard

The rope load wizard will assist you with the uniform adjustment of the ropes. For this purpose the wizard uses the current rope loads as the actual state and calculates a new setpoint load for each rope. The changed load distribution in the ropes is already taken into consideration when readjusting one of the ropes. Due to a special algorithm it will be possible that all ropes bear the same load after only one adjustment run. Also, during each adjustment process the wizard determines a reference rope which does not have to be adjusted (rope 4 in the illustration). The rope load wizard will only be activated when two or more sensors are connected.

Your goal is to adjust the ropes in such a way, that all bars change their colour from red to green and settle within the two thin horizontal lines, which define the tolerance, which you have set in the menu "configuration". Bars above of the central line represent tense ropes whereas bars below the centre line represent loose ropes.

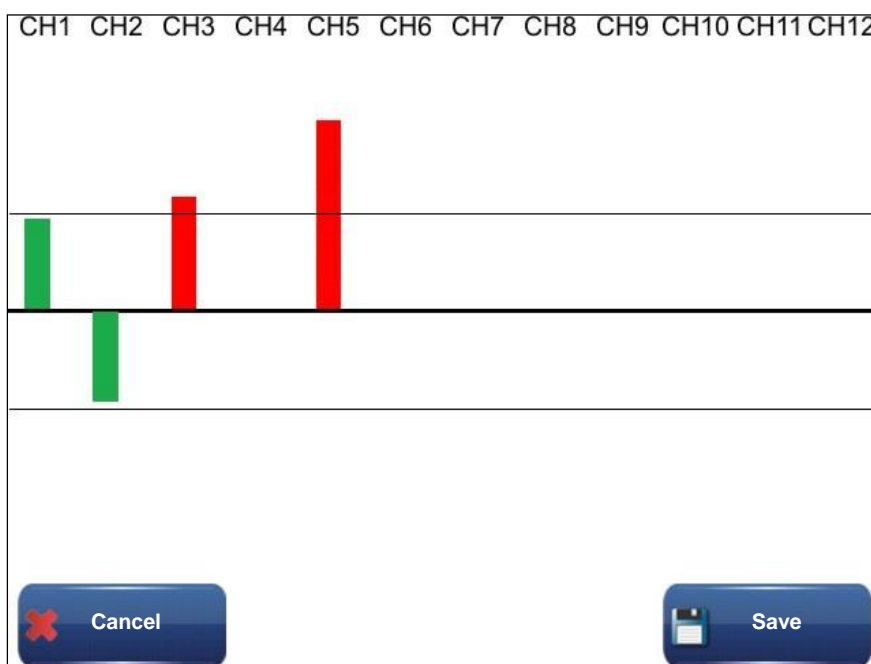

As soon as you leave the wizard by pressing the „save“ key, the data is stored in the unit and you will be able to allocate a project-ID (see also 6.E.3). Data can be processed utilizing the PC-software and reports can be issued.

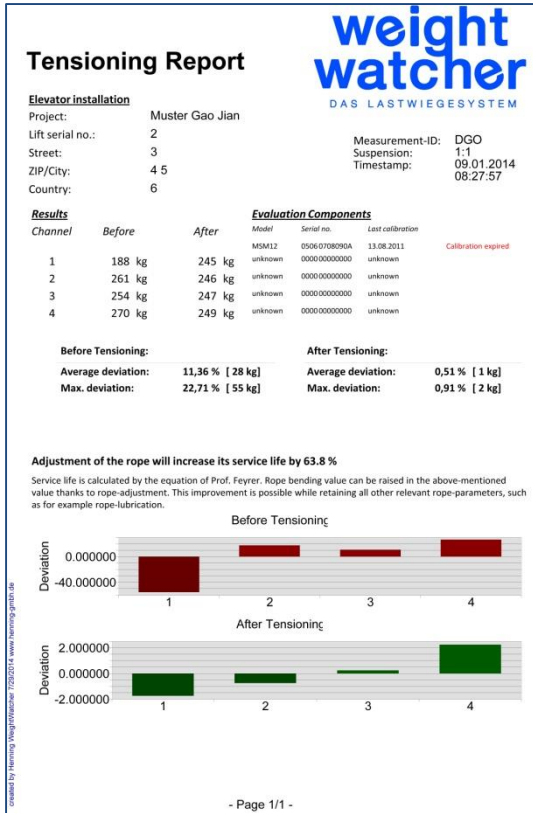

6.H Special Functions

In this part of the menu you will find the software-options available in this particular evaluation-unit.

6.H.1 Continuous Measurements (optional)

Please see chapter 6.E.2

6.H.2 Counterweight Compensation (optional)

This software option allows one to determine the counterweight compensation fast and comfortable.





Rated load 

Cabin weight 

Counterweight 

Compensation factor %

 Cancel  Save

The evaluation unit must be fed the payload of the installation. Please enter it by utilizing the topmost key. A dialogue box will open; please enter the value and save by pressing the “disk-key”.



Afterwards, please install the rope load sensors onto the ropes above the car and press the middle key to determine the weight of the car. Please proceed in the same way with determining the counterweight.

As soon as the unit has been fed all values, the current counterweight compensation will be shown as a percentage. This factor has been calculated according to the following formula:

$$[\text{Compensation-Factor}] = ([\text{Counterweight}] - [\text{Car Weight}]) / [\text{Rated load}]$$

As soon as you leave the dialogue by pressing the key “save”, you can allocate an additional measurement-ID permanently in the unit and issue reports via the PC-software.



**weight
watcher**
DAS LASTWIEGESYSTEM

Half-load Compensation Report

Elevator installation

Project:	Muster Gao Jian		
Lift serial no.:	2		
Street:	3	Measurement-ID:	111
ZIP/City:	4 5	Suspension:	1:1
Country:	6	Timestamp:	09.01.2014 17:03:31

Evaluation Components

Model	Serial no.	Last calibration	
MSM12	0506 0708090A	13.08.2011	Calibration expired
unknown	0000 00000000	unknown	
unknown	0000 00000000	unknown	
unknown	0000 00000000	unknown	
unknown	0000 00000000	unknown	
unknown	0000 00000000	unknown	
unknown	0000 00000000	unknown	
unknown	0000 00000000	unknown	

Car weight: 1050 kg
Counterweight: 1579 kg
Rated load: 630 kg
Balancing factor: 84 % [Balancing factor] = ((Counterweight) - [Car weight]) / [Rated load]

Load modification of the counterweight to achieve a specific balancing factor:

50 %	-214 kg
45 %	-246 kg
40 %	-277 kg
35 %	-309 kg
30 %	-340 kg

created by Henning WeightWatcher 7/2014 | www.henning-gmbh.de

- Page 1/1 -

6.H.3 SyncMaster (optional)

This option will be available in the year 2015

6.I Bluetooth Connection with PC

For the establishment of a wireless Bluetooth connection with the evaluation unit MSM12 a Bluetooth adapter for your PC is required. If the computer is not equipped with such an adapter, you can utilize Henning's optional Bluetooth adapter. Follow the instructions of Windows 7 (and follow up versions) operating system. These instructions will appear as soon as you have connected the Bluetooth adapter to your computer. Do not use the driver CD! In exceptional cases, dependent on your PC-configuration, the Bluetooth adapter is not automatically recognized and installed by the system. In such a case use the installation CD

supplied by Henning and follow the instructions of the installation program. The operating instructions of the Bluetooth adapter are also found on the CD.

In order to utilize the wireless connection between the evaluation unit MSM12 and the computer the MSM12 must be logged onto the PC. Please find below a description of the procedure under Windows. For other operating systems the adjustments should be made correspondingly. The evaluation unit MSM12 uses the Bluetooth PIN:

0000

(four times zero).

In order to log on the MSM12 to the computer, please switch it on. For this purpose press the on / off switch of the device for a minimum 3 seconds. The display should show the Weight Watcher logo as well as a progress bar.

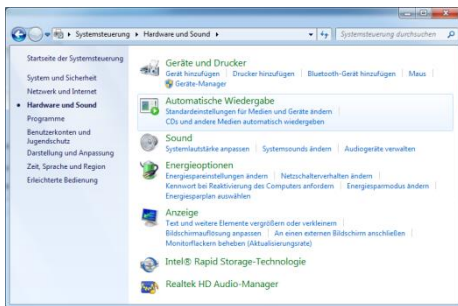

Open the system control. Select “Hardware and Sounds”.



Search for the icon **Bluetooth-Geräte** and open the window with a double click. Make sure, that the MSM12 has been switched on.

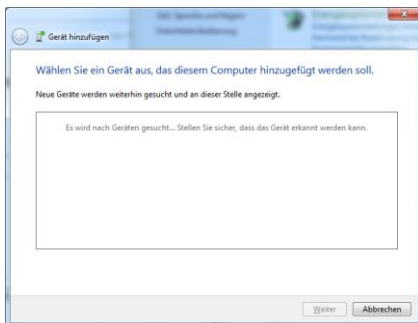

Click on **Hinzufügen...** . [Add...]All available Bluetooth applications will be listed. Select “Weight Watcher MSM12” with a double click.

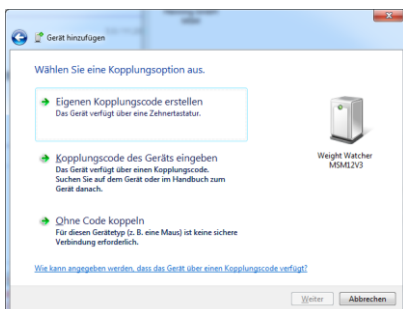

Select the option „insert interconnection code“ in the dialogue box.

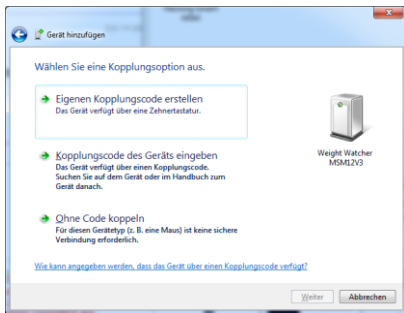

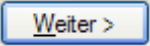
Please enter the PIN 0000 and click  .
[Continue >] to proceed.
The unit will be configured

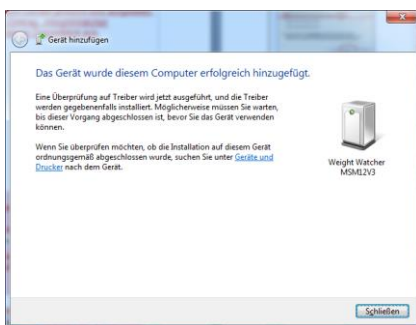

Close the window by clicking [close] .

The MSM12 rope load meter is now listed as a virtual COM port on your Windows system and can be utilized like a MSM12 directly connected via USB.

Please note: firmwareupdates are only possible via USB connection.

6.J Bluetooth Connection with Android Smartphone

Search for the Henning Android App with the keyword “MSM-Wizard” in the Google playstore (<http://play.google.com>). After installing the app, the wizard will guide you through the necessary steps for establishing a connection between the evaluation unit MSM12 and your smartphone / tablet. Please make sure that the MSM12 is switched on and within blue-tooth-range. Thereafter you will be able to run the rope adjustment wizard on your mobile device, if the MSM12 is within Bluetooth-range, which will be very usefull for machin-roomless elevators.

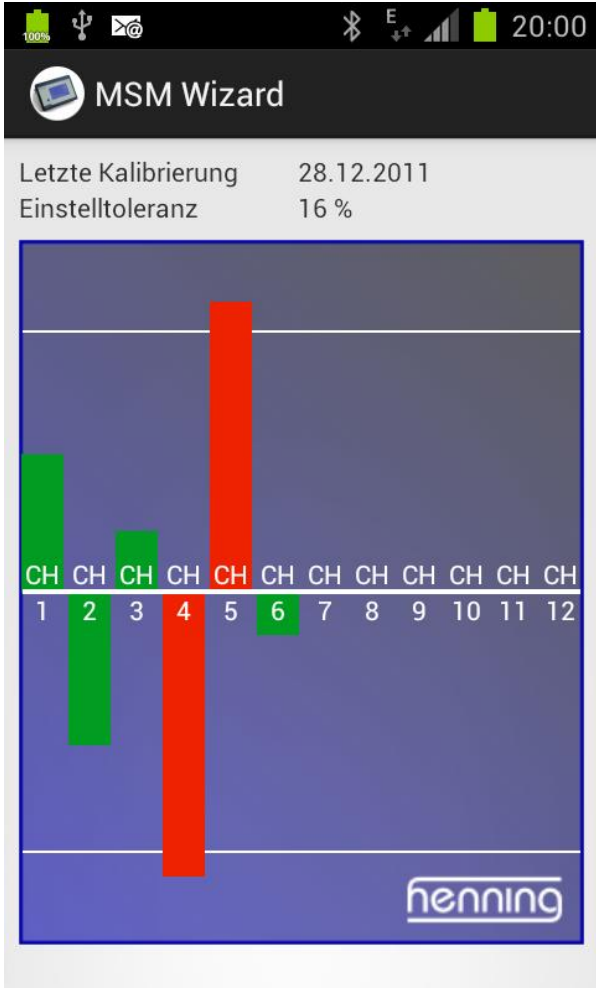

7 Operating the Sensors

7.A General Notes

Operation

The rope load sensors are based on a patented measuring method which allows to carry out absolute measurements without the need to calibrate the system with weights. The sensor contains a strain gauge, the signals of which are being conditioned by integrated electronics and transmitted via the USB connector of the sensor to the evaluation unit MSM12. Each sensor is calibrated individually.

Connections

Each LSM sensor features cable with USB-A connector to connect them to the evaluation unit MSM12. The sensors have no other connecting options.

Handling

To ensure that there is always good electrical contact please keep the sensor plugs free from dust, liquids etc..

7.A.1 Positioning of Sensors on the Rope

The sensors must be mounted with a minimum clearance of 200 mm to the rope clamps, as a non perpendicular running cable may distort the result of the measurement.

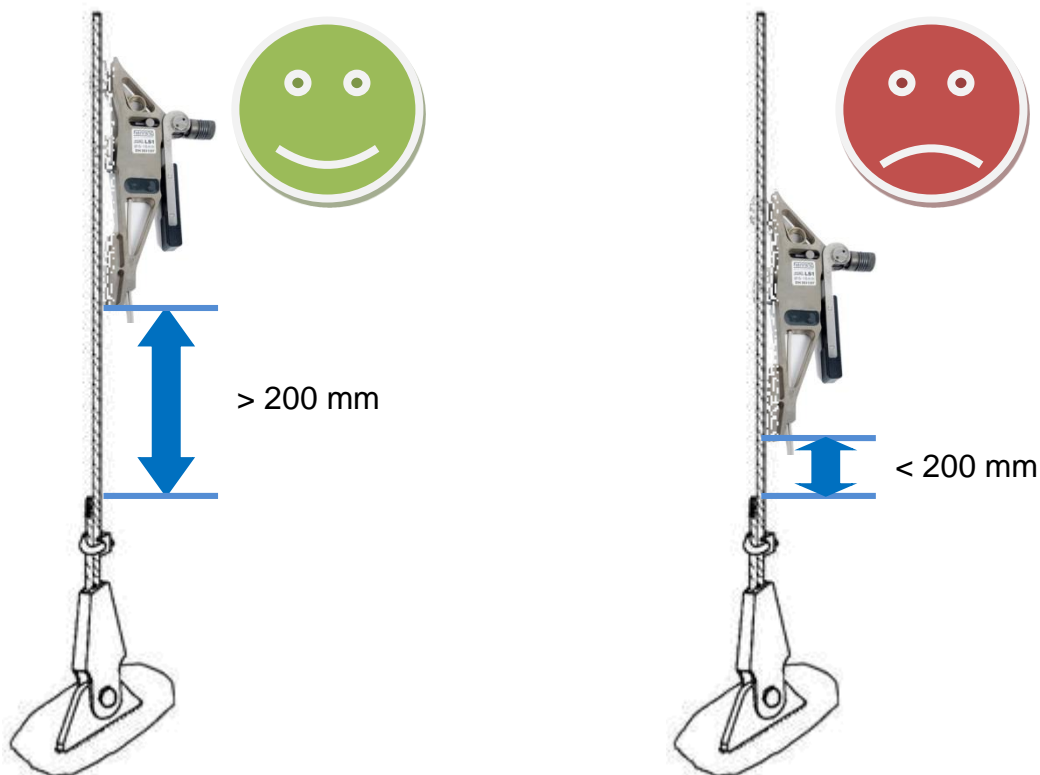

! Attention: for an accurate measurement, the sensor may be clamped only once onto a particular space in a rope.

7.A.2 Positioning of Sensors depending on Suspension Type

1:1 Suspension

CABIN

COUNTERWEIGHT

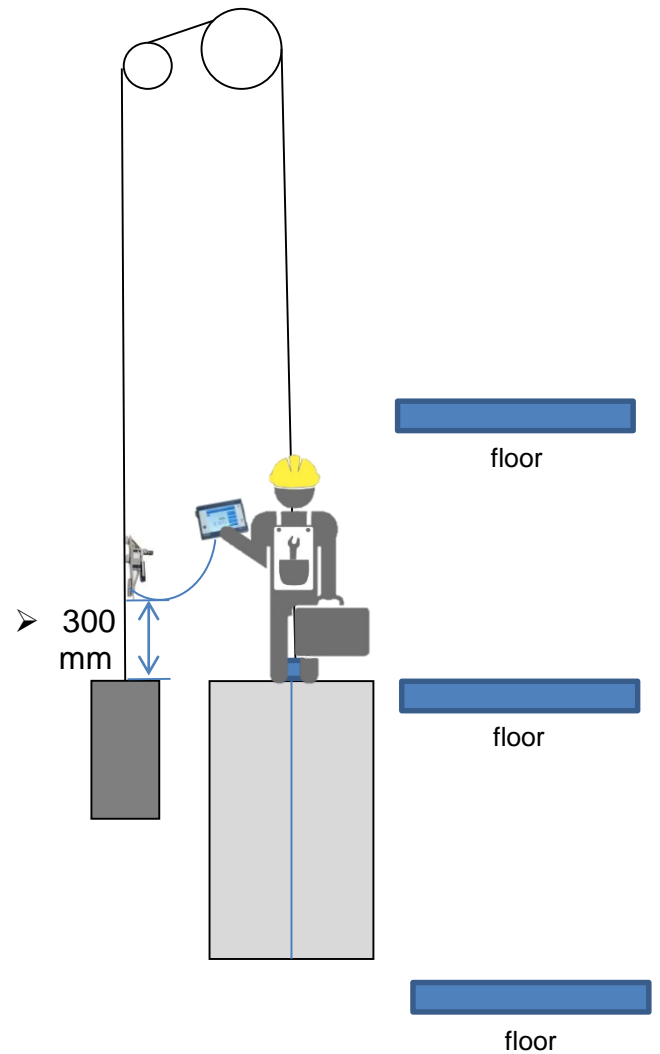
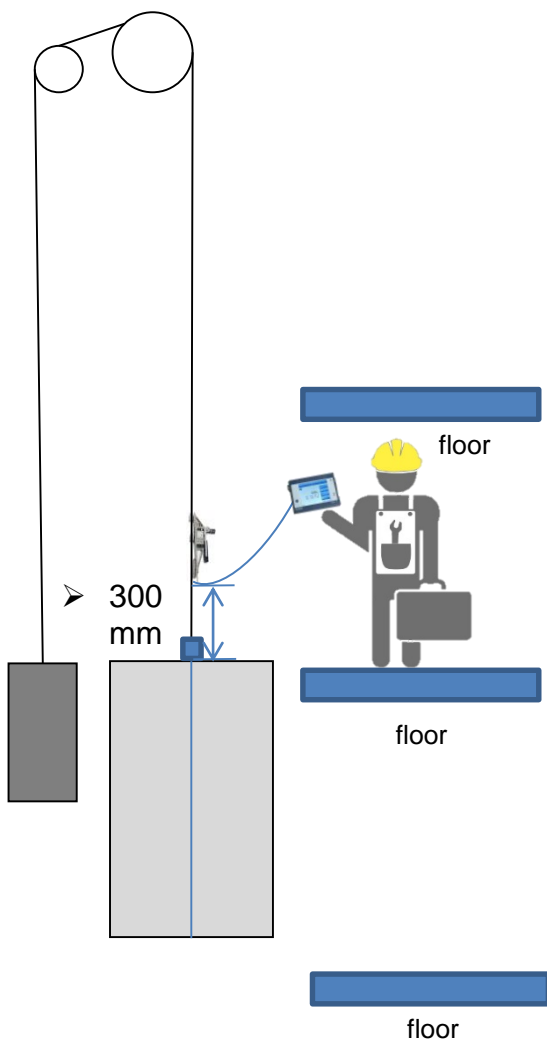

1:1 Suspension

CABIN

COUNTERWEIGHT

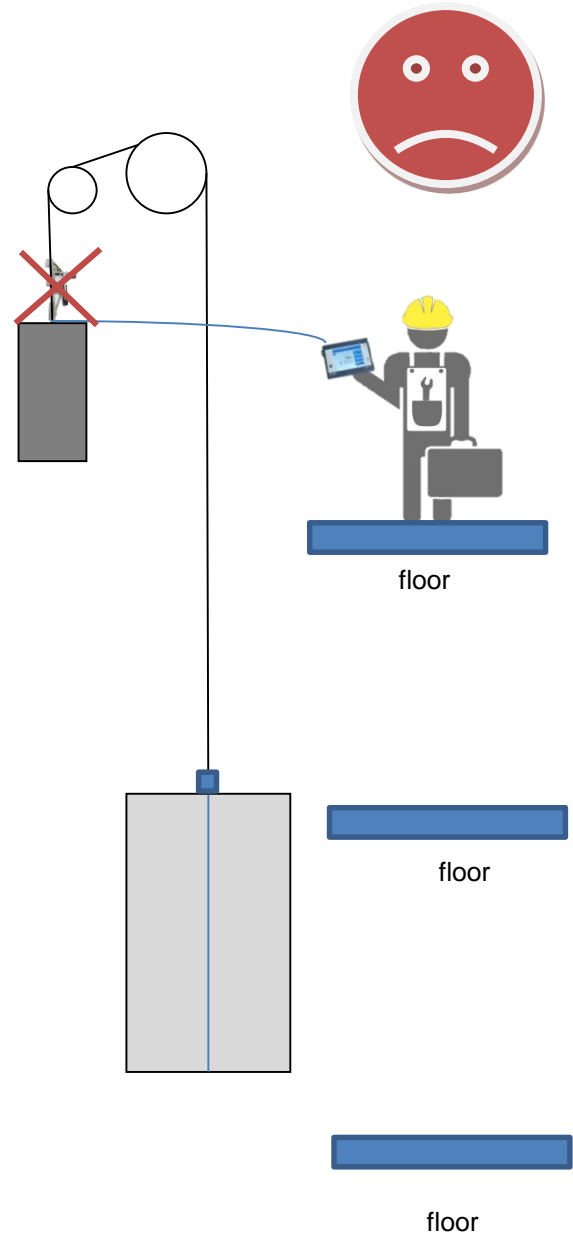
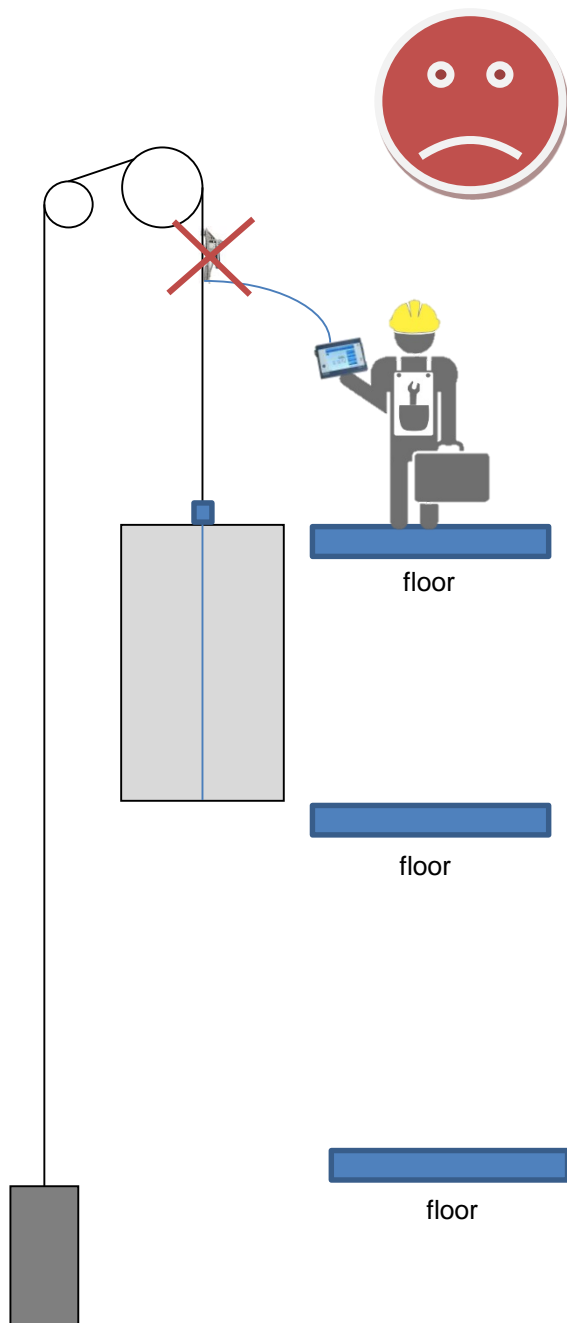

2:1 Suspension MEASUREMENT CABIN

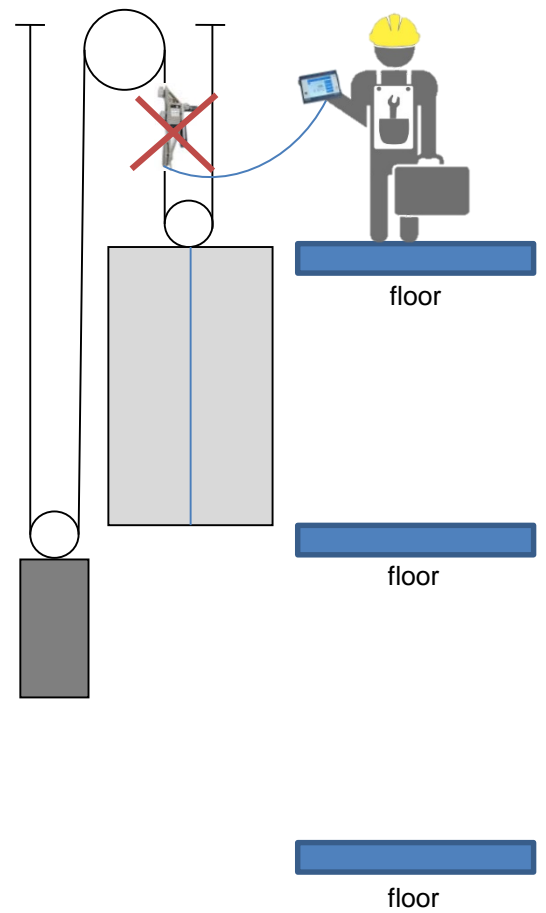
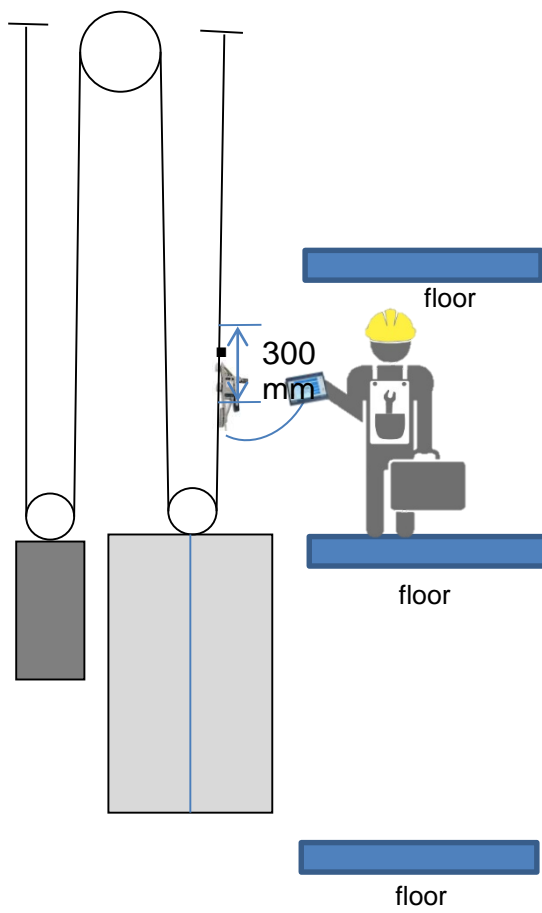

2:1 Suspension

MEASUREMENT COUNTERWEIGHT

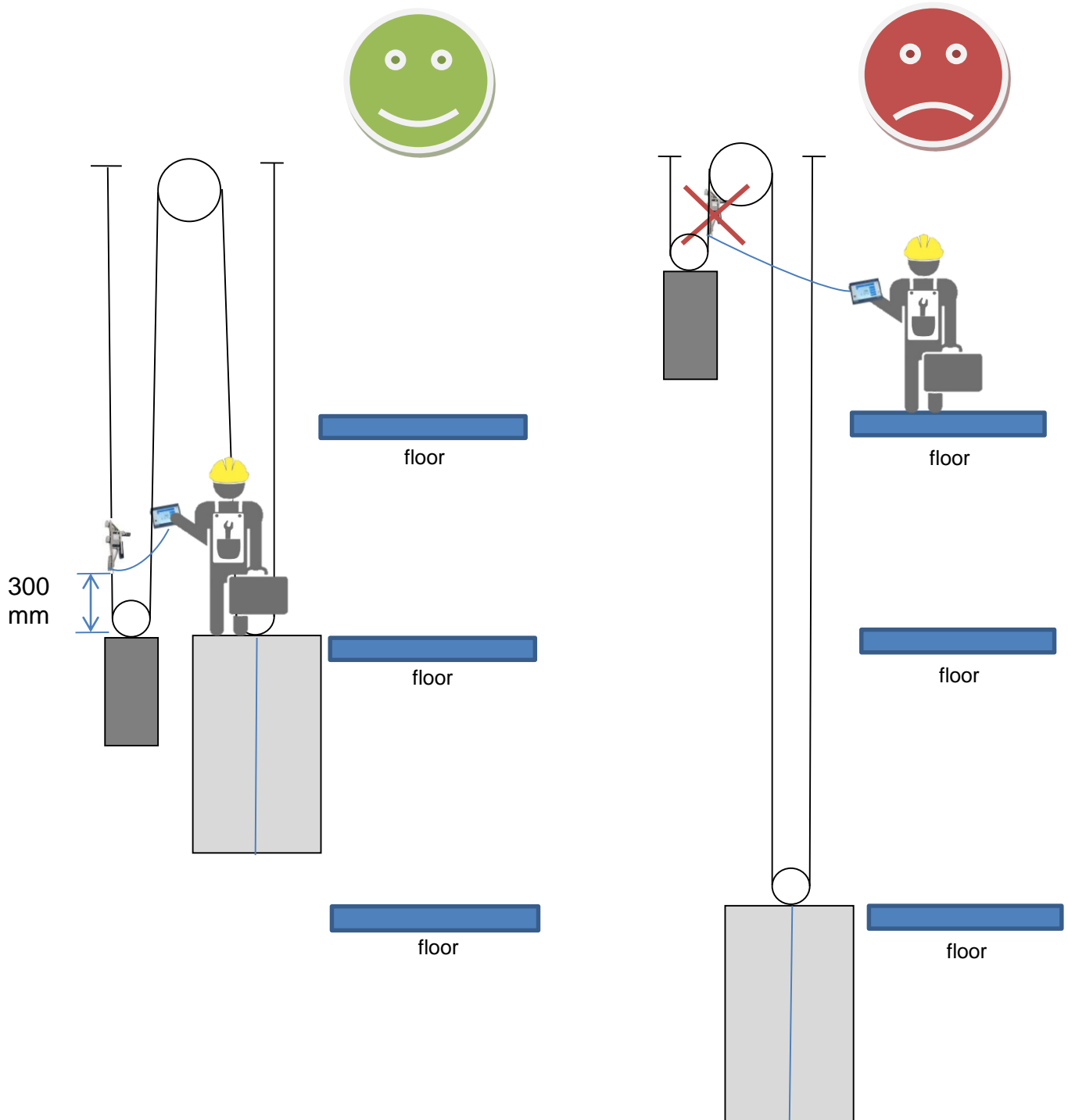

1:1 Suspension Compensation chain

CABIN

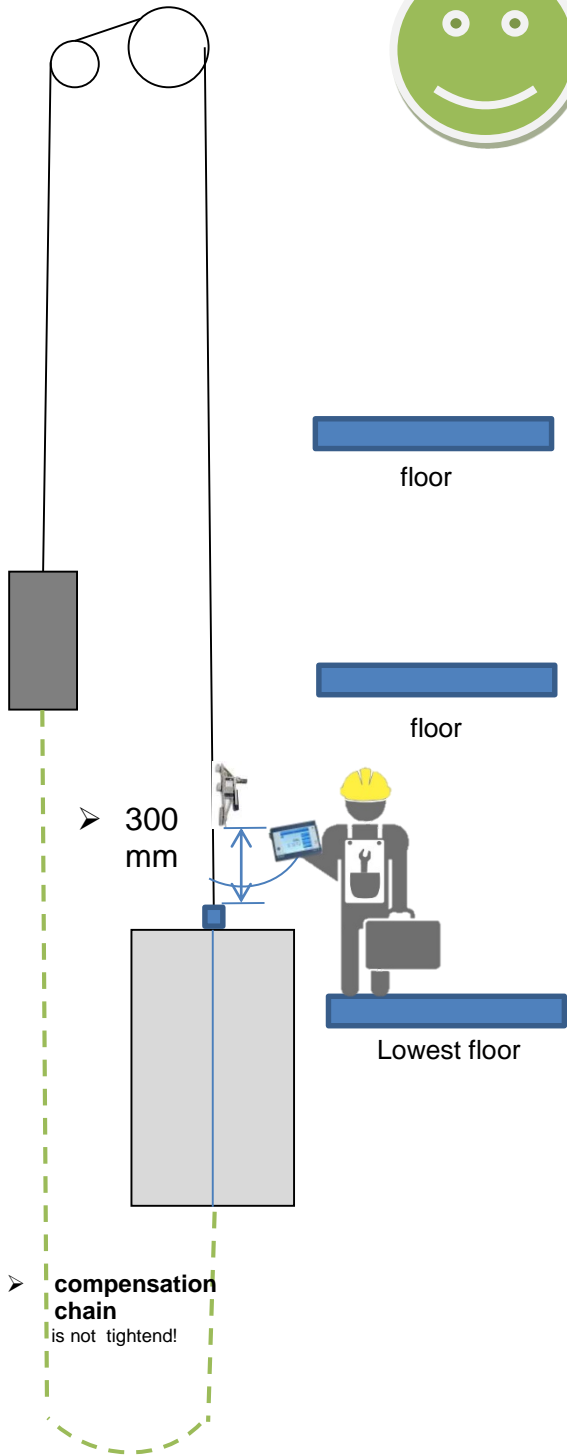

COUNTERWEIGHT

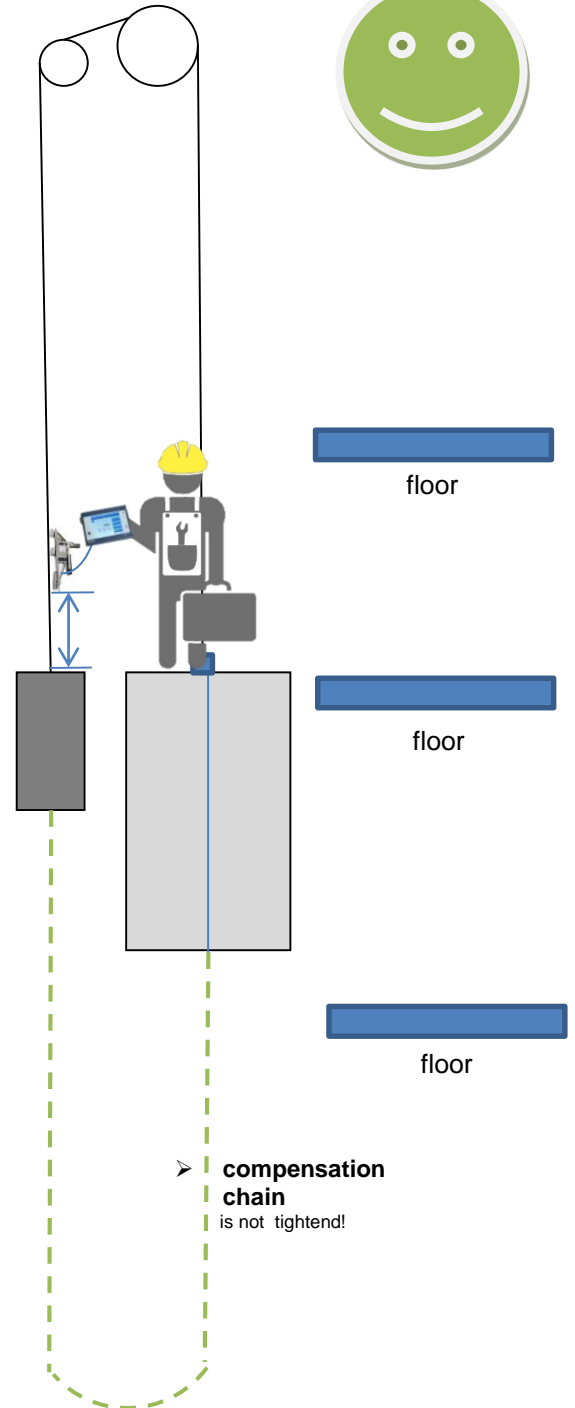

Step 1

1:1 Suspension with fixing weight

MEASUREMENT COMPENSATIONROPE / CABIN

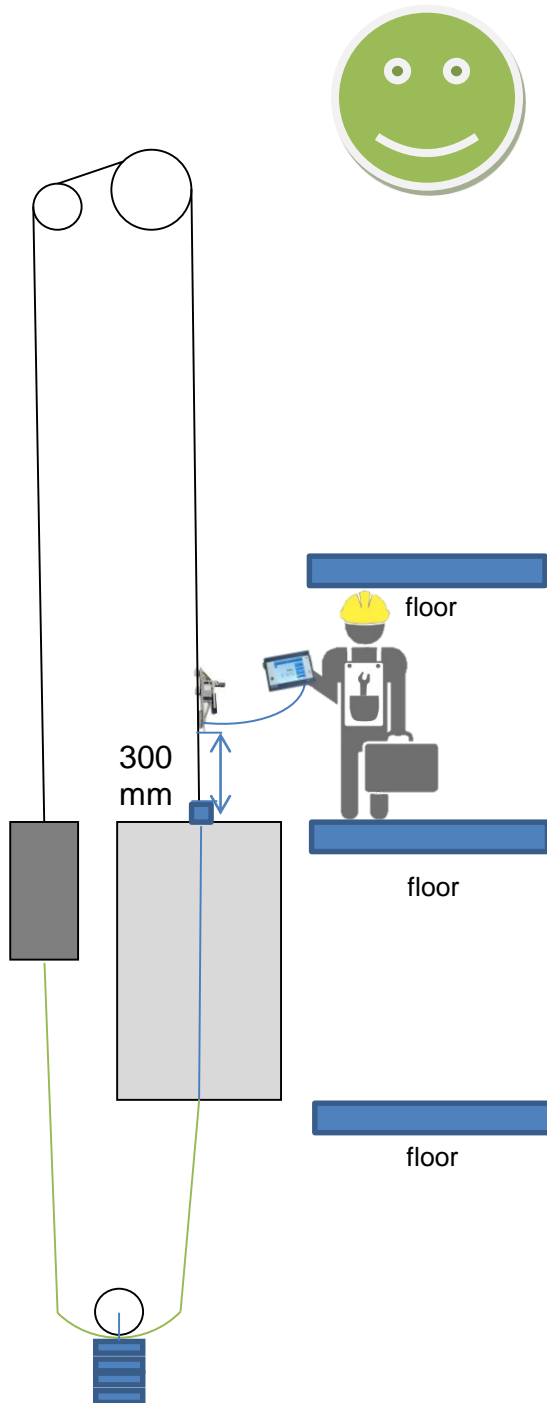

Step 2

1:1 Suspension with fixing weight

MEASUREMENT COMPENSATION ROPE/COUNTERWEIGHT

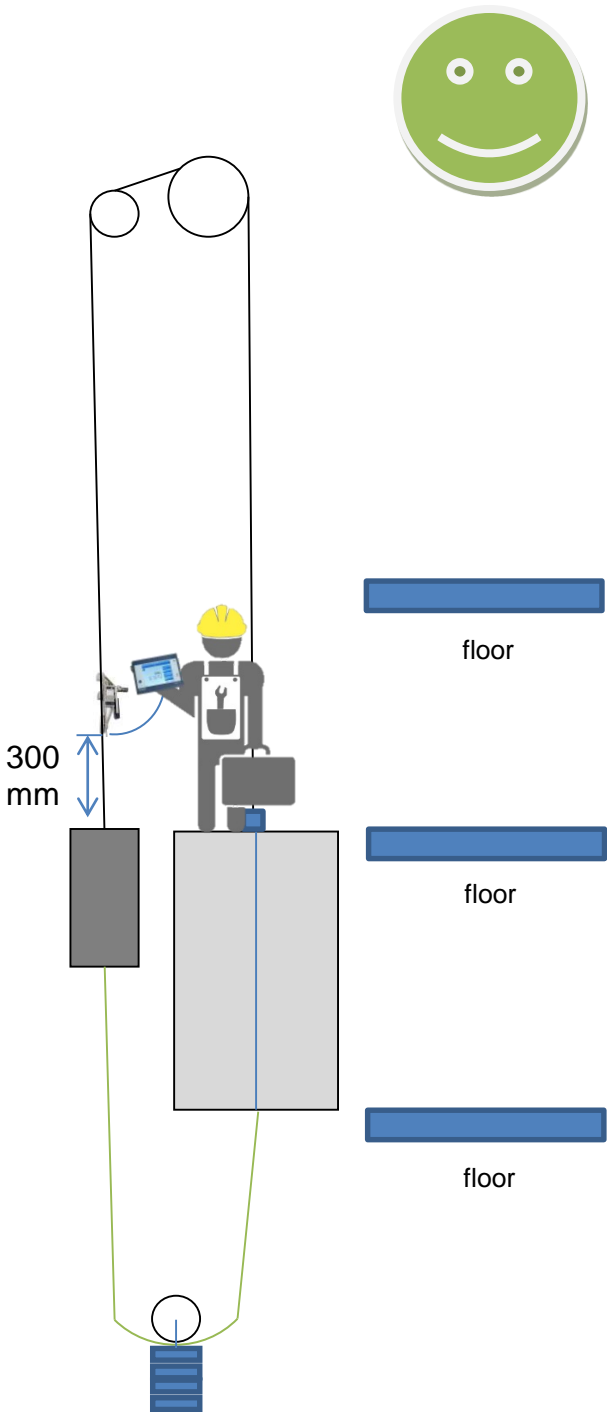

Step 3

1:1 Suspension with fixing weight

MEASUREMENT COMPENSATION ROPE

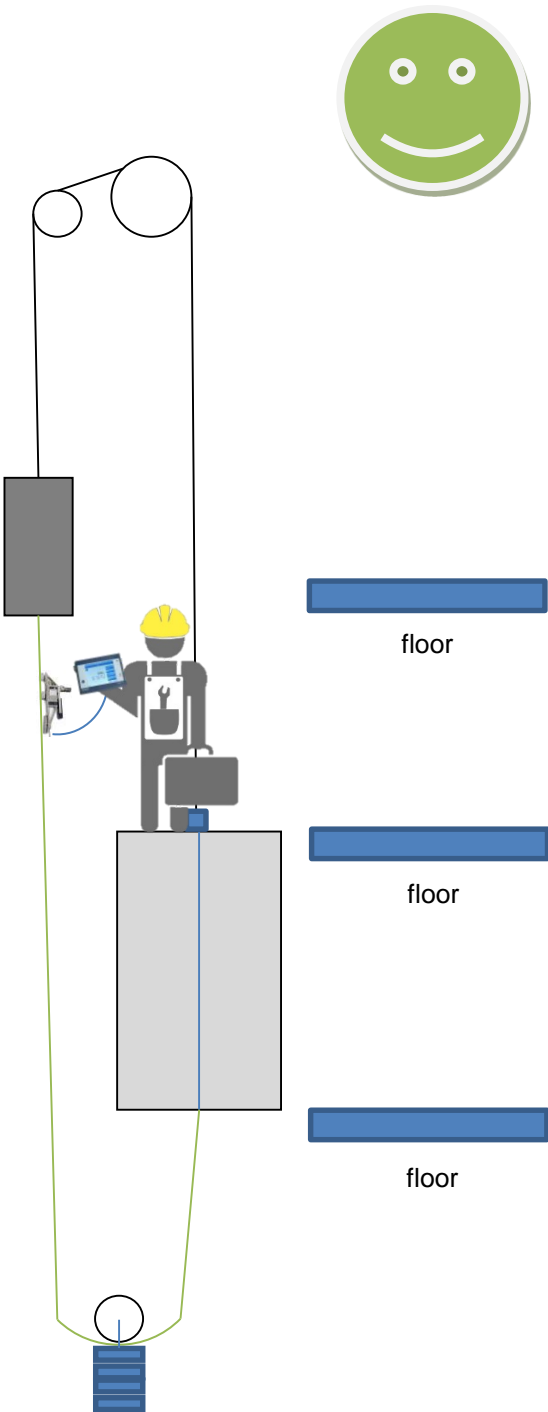

7.A.3 Rope Adjustment

Generally, the sensors should be mounted in the section of the rope which features maximum lengths without intermediate deflections or traction sheaves, as the ropes will be balancing out only very slightly or none at all during standstill.

If this is not possible due to the layout of the elevator, several rope settings may be carried out in succession. In between the adjustment procedures, the elevator should be driven several times in order to compensate the ropes loads across the traction sheave.

7.A.4 Friction / Determination of Weight

Due to heavy friction of the car or the counterweight in the guide rails the measuring result may be negatively affected. In such a case it is preferred to determine the weight during a constant travel. This effect is found particularly often in the case of rucksack guides. With roller guides this effect is found generally less frequently than with slide type guides.

If possible, clamp the sensors onto the rope directly above the load to be measured (≥ 200 mm) and subsequently travel a short distance upward with constant speed. If there is no difference between the indicated load during the constant travel and while standing still, there is no friction to speak of in the guides and it will not be necessary to carry out the measurement during travel.

If there is a significant difference between the travel and the standstill value, make a note of the value measured during the upward travel and then start a downward travel with constant speed. Make a note of this value too.

The average of the readings obtained during upward and downward travel is the real weight without friction.

By this trick of traveling upwards and downwards and the subsequent determination of an average value you have eliminated the dynamic and static friction of the elevator from the measurements.

! Attention: In the case of multi-suspensions, please take extra special care that the sensors are not overrun during the measuring travels!

7.B Installation of Sensors LSM1 und LSM2

1. Bring the clamp lever into the “open” position. Place the sensor onto the rope. If this is not possible, open the adjustment-screw several turns. When the sensor is placed on the rope, turn the adjustment-screw in such a way, that the marker matches the appropriate rope diameter on the label. This is only a rough adjustment, the fine tuning will be done by the green o-ring on the adjustment-screw.
2. Now close the clamp lever and taking care that the cable still runs correctly in the sensor groove.
3. Connect the sensor LSM to the evaluation unit MSM12 via the USB cable.



Step 1



Step 2



Step 3

After installation, the correct sensor adjustment should be verified, to ensure that the sensor has been fitted with the right force. The clamping force is correct, if the edge of the adjustment screw's silver cylinder is positioned in the center of the green o-ring. If the edge of the silver cylinder is not positioned inside the O-ring, the clamping force is wrong and the installation should be repeated.

The following pictures show correctly and incorrectly adjusted rope load sensors:

Incorrectly adjusted:

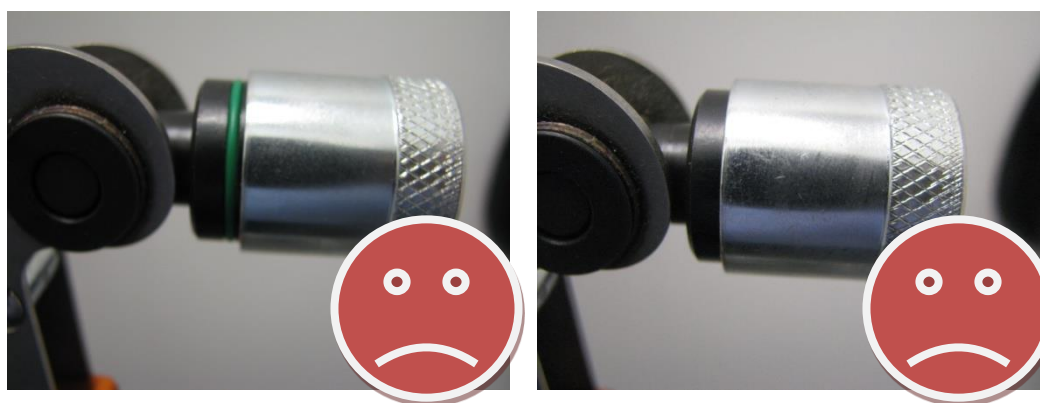

Correctly adjusted:



7.C Installation of Sensors LSM-XL

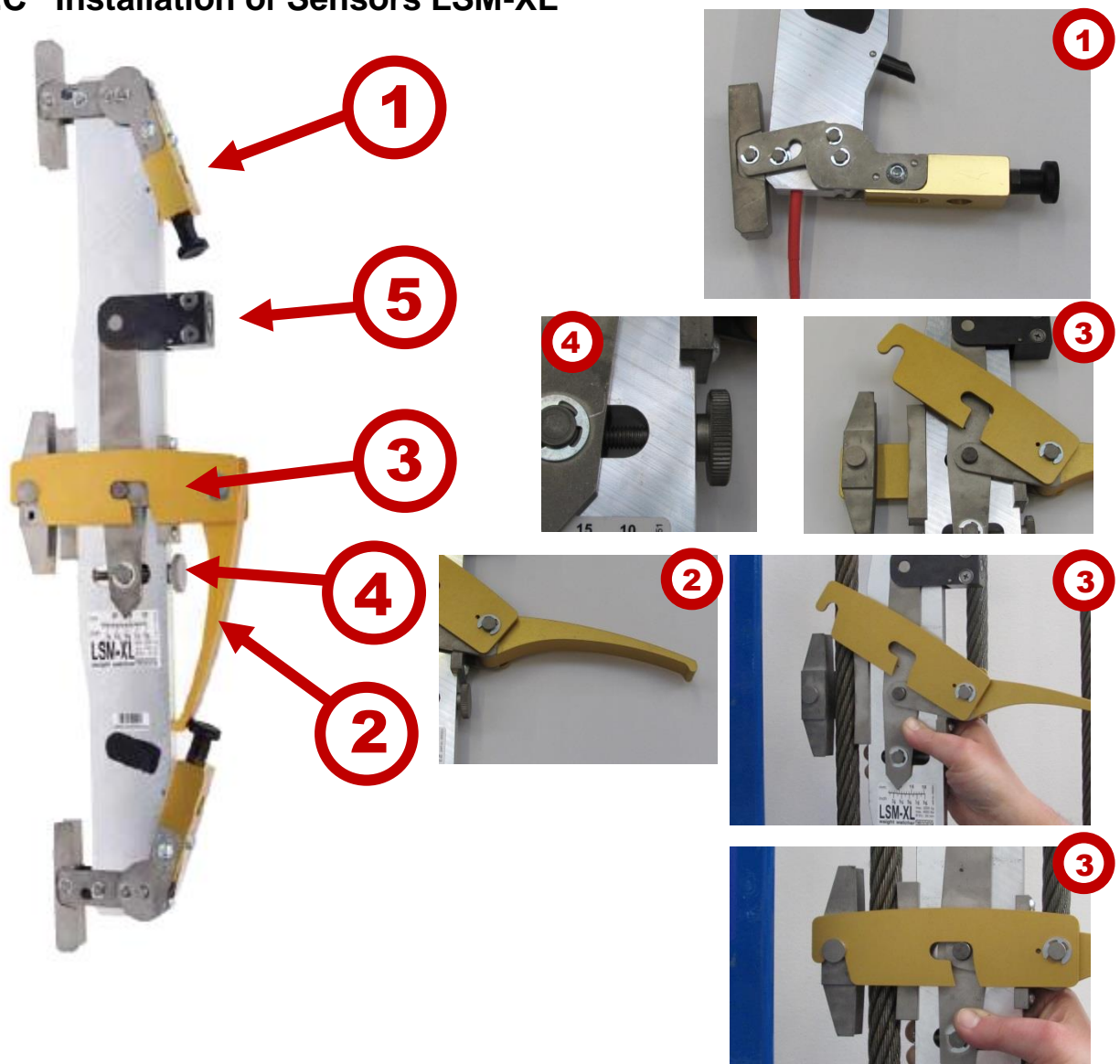

Open both levers 1 as well as lever 2, open strap 3. Adjust the sensor by means of the adjustment screw 4 roughly to the rope diameter and mount the sensor onto the rope. Close strap 3 and after lever 2.

Check the clamping force on indicator 5. If the clamping force is correct, half of the green O-ring will be visible. If this is not the case, open lever 2 again and adjust the clamping force by means of the adjustment screw 4. Close lever 2 again and close both levers 1.

The following pictures show correctly and incorrectly adjusted rope load sensors:
Incorrectly adjusted:

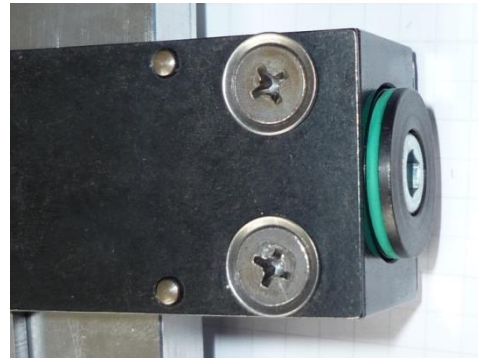

Correctly adjusted:

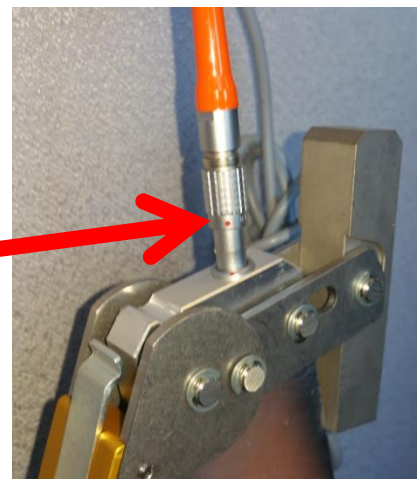

IMPORTANT ADVICE:

Take care when inserting or removing the cord plugset.

Handle by the plug unit, **never pull** the electrical cord. Align red dot on plug with red dot on receptacle of the Sensor.

Forcing the plug in or out will damage pins and severely damage sensor which will require unnecessary/costly repairs.

7.D Installation of Sensors LSM-BELT

Place the sensor onto the belt and close the strap at the side. Make sure that the belt is positioned correctly in the in the sensor's corresponding groove. If the belt has only grooves on one side, the flat side should be facing towards the sensor body.



After installation, the correct sensor adjustment should be verified, to ensure that the sensor has been fitted with the right force. The clamping force is correct, if the edge of the adjustment screw's silver cylinder is positioned in the center of the green o-ring. If the edge of the silver cylinder is not positioned inside the O-ring the sensor is incorrectly mounted.

Incorrectly adjusted:



Correctly adjusted:



**IMPORTANT:
DO NOT ADJUST SCREWS AS IT WILL VOID CALIBRATION OF SENSOR!**

Belt versions:
OTIS

SCHINDLER

CONTITECH





Henning GmbH & Co. KG
Loher Str. 4
58332 Schwelm
Deutschland

FON: 02336 / 9 29 8 – 0
FAX: 02336 / 9 29 8 – 100

eMail: info@henning-gmbh.de
URL : <http://www.henning-gmbh.de>

Service-Hotline: 02336 / 9 29 8 - 232